

4650 Z

AC axial compact fan



ebm-papst St. Georgen GmbH & Co. KG

Hermann-Papst-Str. 1
D-78112 St. Georgen
Phone +49 (0) 7724 81-0
Fax +49 (0) 7724 81-1309
info2@de.ebmpapst.com
www.ebmpapst.com

Nominal data

Type	4650 Z	
Phase		1~
Nominal voltage	VAC	230
Frequency	Hz	50
Speed	min ⁻¹	2650
Power input	W	19.0
Min. ambient temperature	°C	-10
Max. ambient temperature	°C	50
Air flow	m ³ /h	160
Sound power level	B	5.3
Sound pressure level	dB(A)	40

ml = Max. load · me = Max. efficiency · fa = Running at free air · cs = Customer specs · cu = Customer unit
Subject to alterations



Technical features

Mass	0.540 kg
Dimensions	119 x 119 x 38 mm
Material of impeller	Sheet steel, coated in black
Housing material	Die-cast aluminium
Direction of air flow	Exhaust over struts
Direction of rotation	Right, looking at rotor
Bearing	Sintec sleeve bearing
Lifetime L10 at 40 °C	37500 h
Lifetime L10 at maximum temperature	30000 h
Connection line	2 flat connectors 2.8 x 0.5 mm. Housing with grounding lug for M4 x 8.
Motor protection	Protected from overload using impedance protection
Approval	VDE, CSA, UL, CE
Option	Available with electrical terminals on single strands that are 310 mm in length.



Product drawing

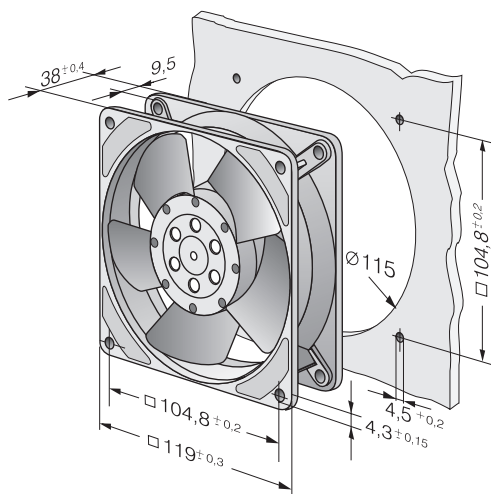

Charts: Air flow

